

**433

*118

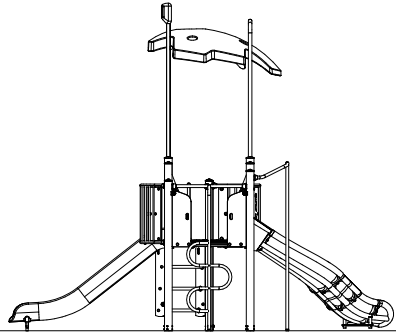

PCE211522
1:100