

**463

*220

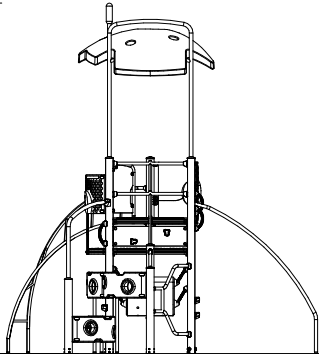

PCE110221
1:100