

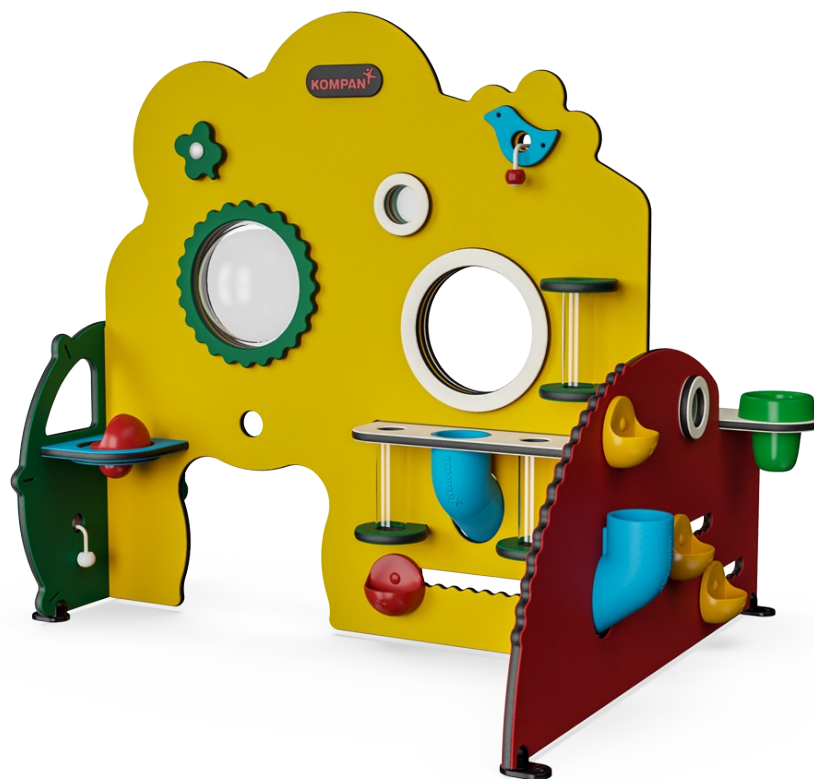

Green House & Florist

MSV604

KOMPAN
Let's play



Item no. MSV60400-0201	
General Product Information	
Dimensions LxWxH	146x120x121 cm
Age group	6m+
Play capacity (users)	8
Color options	

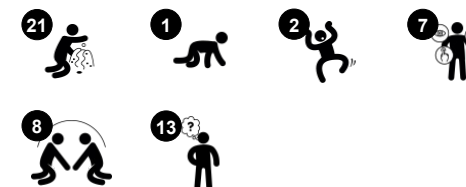

Wow! Children are immensely attracted to the activity of the Green House & Florist. In a small space, children play intensely, again and again. Loaded with play, the play unit benefits the children's physical, social-emotional, cognitive and creative development. Numerous play features encourage social play as they unite children with tangible, cross-panel play

activities: the tube, sand scoop and string with knob. The Green House & Florist has tangible themes: switch, bell, scoops making sounds when run in the toothed grooves, see-through flower vases. These scaffold logical thinking skills as children push, pull and investigate the numerous play items stimulate the child's logical thinking skills. The rich themes in-spire

dramatic play, which is phenomenal for language development: a main factor for learning, friendships and life success.



Data is subject to change without prior notice.

Green House & Florist

MSV604



Panels of 19mm EcoCore™. EcoCore™ is a highly durable, eco friendly material, which is not only recyclable after use, but also consists of a core produced from 100% recycled post consumer material from food packing waste.

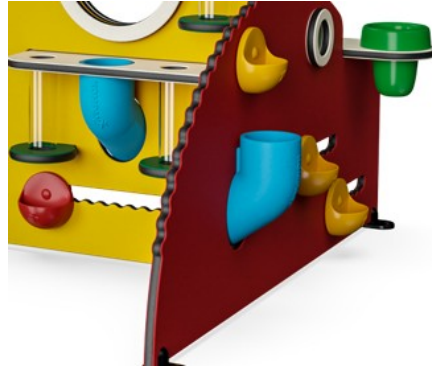

Sand pipe is made from rotomoulded PE. PE has high impact resistance across a wide temperature span which ensures durability.



Pots are made of pressure moulded high quality nylon (PA6). PA6 has good wearing and impact strength.

Item no. MSV60400-0201

Installation Information

Max. fall height	0 cm
Safety surfacing area	14.9 m ²
Total installation time	5.1
Excavation volume	0.00 m ³
Concrete volume	0.00 m ³
Footing depth (standard)	0 cm
Shipment weight	52 kg
Anchoring options	Surface ✓

Warranty Information



On the side of the wall there is a transparent bubble made from UV-stabilised PC.

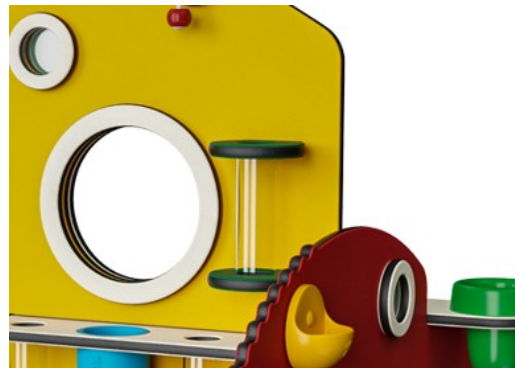

See-through tubes are made of PPMA. PPMA has outstanding durability and resistance to UV radiation.



Green House & Florist

MSV604

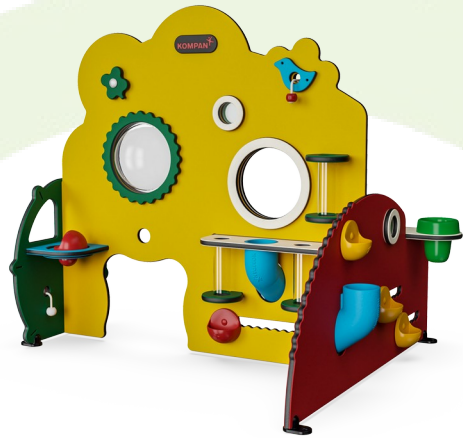

Cradle to Gate A1-A3	Total CO ₂ emission	CO ₂ e/kg	Recycled materials
	kg CO ₂ e	kg CO ₂ e/kg	%
MSV60400-0201	87.30	1.78	70.90

The overall framework applied for these factors is the Environmental Product Declaration (EPD), which quantifies "environmental information on the life cycle of a product and enable comparisons between products fulfilling the same function" (ISO, 2006). This follows the structure and applies a Life-Cycle Assessment approach to the entire Product stage from raw material through manufacturing (A1-A3))

Kompan A/S
C.F. Tietgens Boulevard 32C
DK-5220 Odense SØ
Denmark

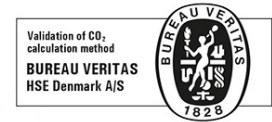

Validation of CO₂ calculation of: Themed play systems

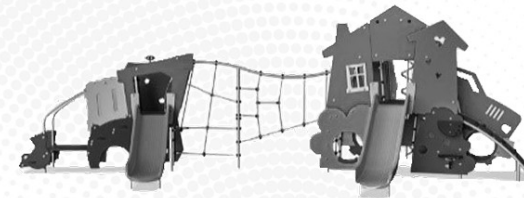

Data version no. 2021-09-27

The CO₂ calculation and data are in compliance with the principles of a carbon footprint impact according to the GHG protocol (Greenhouse Gas Protocol), Scope 3, cradle to gate related to all individual components in the product category: "Themed play systems" represented by item no.: MSC641100-3717P.

(Scope 3 emissions include emission sources in the upstream and downstream value chain).

Date: 15. October 2021 | Valid until: 15. October 2023

Validated by:

Bente Hviid, Senior Consultant

Peter Bendtsen, Senior Consultant

Validation based on report: Validation of CO₂ calculation of 8 categories of Kompan product line, version 1.0, prepared by: Bureau Veritas HSE, Denmark: Bente Hviid and Peter Bendtsen.

Publication date: 15. October 2021

By Bureau Veritas HSE
www.bureauveritas.dk
+45 7731 1000



Green House & Florist

MSV604

* Max fall height | ** Total height | *** Safety surfacing area

* Max fall height | ** Total height

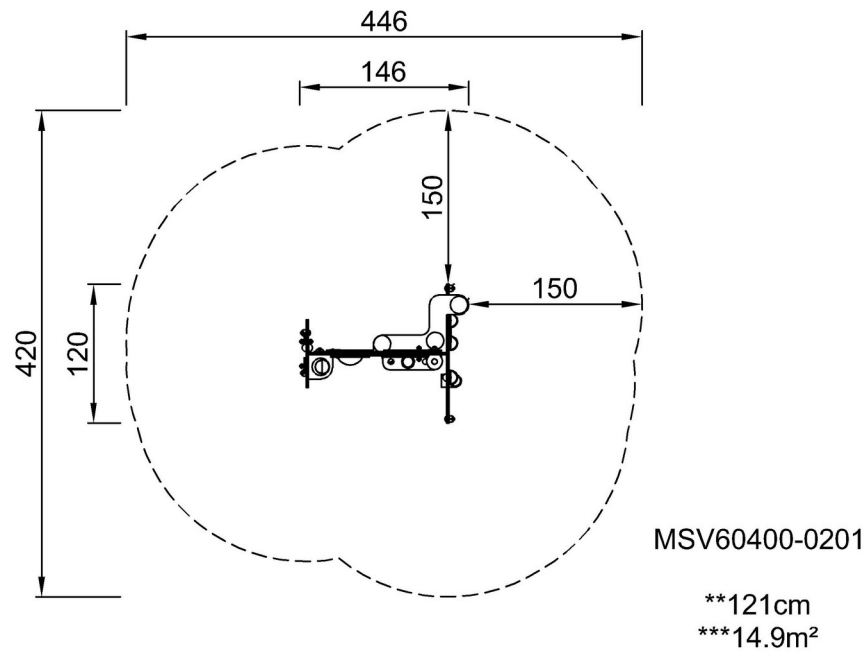

MSV60400-0201

[Click to see TOP VIEW](#)

[Click to see SIDE VIEW](#)