

Octopus Seesaw

M181



Item no. M18110-01P

General Product Information

Dimensions LxWxH	31x313x98 cm
Age group	3+
Play capacity (users)	4
Color options	 

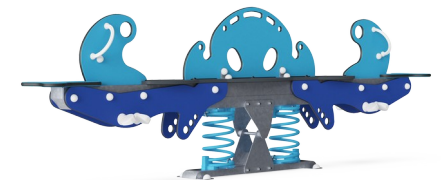

The Octopus seesaw helps to motivate children to join in play, so they are rocking together. The cartoonish design attracts children and makes them want to play. The sturdy hand and foot supports allow for mild or wild rocking, depending on the child's energy level. The spring base makes it possible for a range of ages to rock together. The octopus head in the

middle supports an upright seat and holding tight while being rocked. This allows for more socializing and more children. There is room enough for a care giver, too. The seats at the end are big enough for older children as well as adults. The fun thrill of rocking, individually or in pairs or groups, will make children want to play for longer. Rocking on the Octopus seesaw

trains the children's muscles and motor skills, e.g. balance and coordination. The seesaw supports development of social-emotional skills, e.g. cooperation, consideration and turn-taking.

Octopus Seesaw

M181



Panels of 19mm EcoCore™. EcoCore™ is a highly durable, eco friendly material, which is not only recyclable after use, but also consists of a core produced from 100% recycled post consumer material from food packing waste.

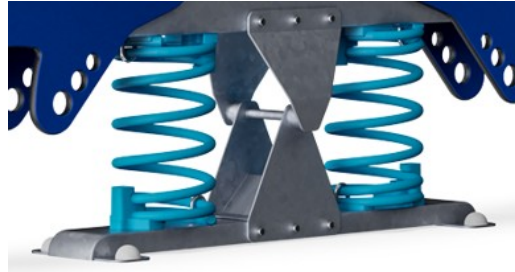

KOMPAN Springs are made of high quality spring steel according to EN10270. The springs are cleaned by phosphating before they are painted with an epoxy primer and a polyester powder coating as top finish. The springs are fixed by unique anti pinch fittings for maximum safety and long lifetime.



The springs are fixed by unique anti pinch fittings for maximum safety and long lifetime.

Item no. M18110-01P	
Installation Information	
Max. fall height	100 cm
Safety surfacing area	13.7 m ²
Total installation time	4.9
Excavation volume	0.42 m ³
Concrete volume	0.00 m ³
Footing depth (standard)	42 cm
Shipment weight	184 kg
Anchoring options	In-ground ✓ Surface ✓
Warranty Information	



Handholds and footrests are made of injection moulded high quality nylon (PA6). PA6 has good wearing and impact strength.

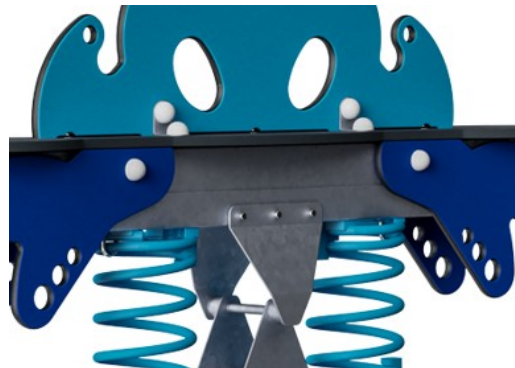

The steel support posts are hot dip galvanised inside and outside with lead free zinc. The galvanisation has excellent corrosion resistance in outside environments and requires low maintenance.

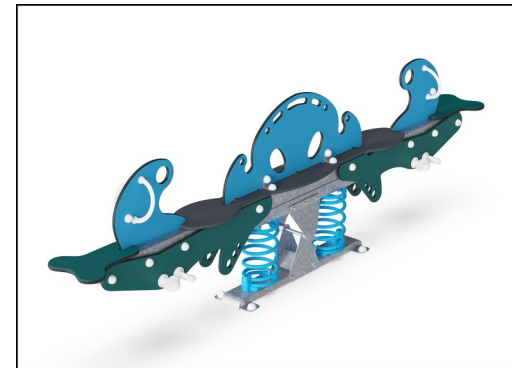

KOMPAN GreenLine versions are designed with ultimate environmentally friendly materials with lowest possible CO2e emission factor such as EcoCore™ panels of 100% post consumer recycled ocean waste.



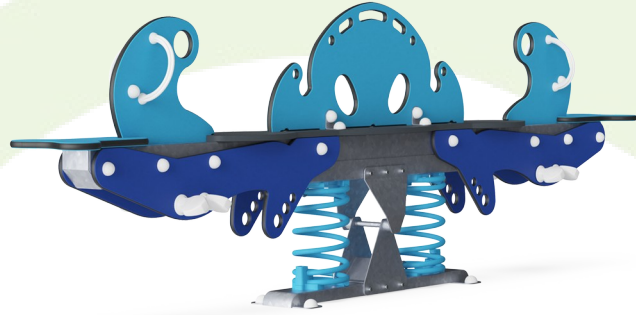

Cradle to Gate A1-A3	Total CO ₂ emission	CO ₂ e/kg	Recycled materials
	kg CO ₂ e	kg CO ₂ e/kg	%
M18110-01P	294.90	2.27	45.90
M18113-01P	303.00	2.33	48.40

The overall framework applied for these factors is the Environmental Product Declaration (EPD), which quantifies "environmental information on the life cycle of a product and enable comparisons between products fulfilling the same function" (ISO, 2006). This follows the structure and applies a Life-Cycle Assessment approach to the entire Product stage from raw material through manufacturing (A1-A3))

Kompan A/S
 C.F. Tietgens Boulevard 32C
 DK-5220 Odense SØ
 Denmark



Validation of CO₂ calculation of: Freestanding play equipment



Data version no. 2021-09-27

The CO₂ calculation and data are in compliance with the principles of a carbon footprint impact according to the GHG protocol (Greenhouse Gas Protocol), Scope 3, cradle to gate related to all individual components in the product category: "Freestanding play equipment" represented by item no.: GXY916012-3417.

(Scope 3 emissions include emission sources in the upstream and downstream value chain).

Date: 15. October 2021 | Valid until: 15. October 2023

Validated by:

Bente Hviid, Senior Consultant

Peter Bendtsen, Senior Consultant

Validation based on report: Validation of CO₂ calculation of 8 categories of Kompan product line, version 1.0, prepared by: Bureau Veritas HSE, Denmark: Bente Hviid and Peter Bendtsen.

Publication date: 15. October 2021

By Bureau Veritas HSE
 www.bureauveritas.dk
 +45 7731 1000



Octopus Seesaw

M181

* Max fall height | ** Total height | *** Safety surfacing area

* Max fall height | ** Total height

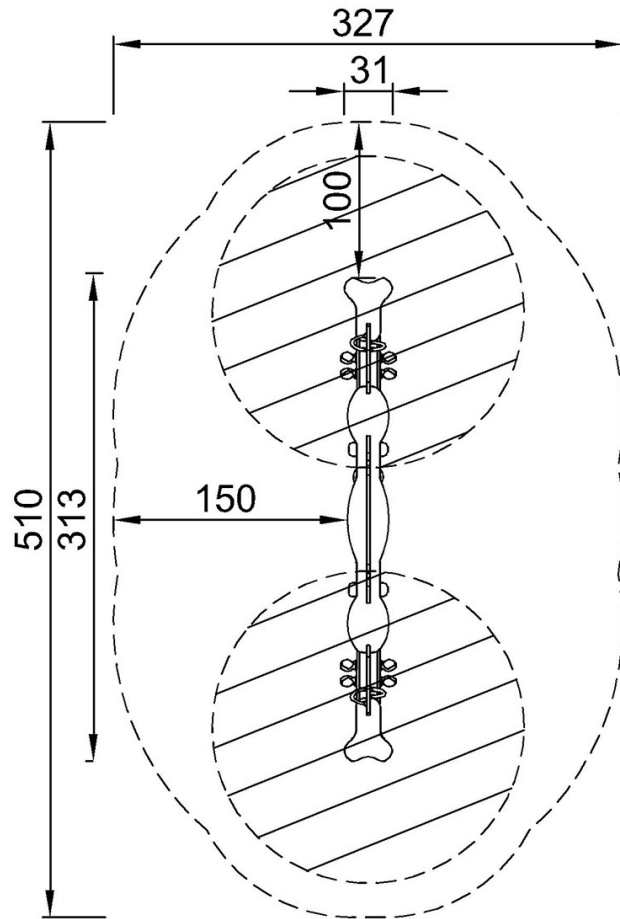

M18113
*100cm
**98cm
***13.7m²

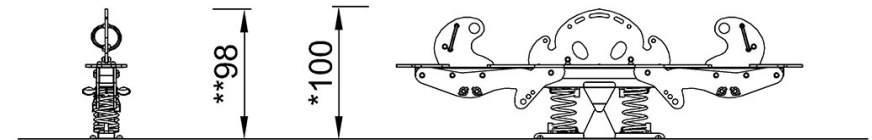

M18110

[Click to see TOP VIEW](#)

[Click to see SIDE VIEW](#)