

Bench C 60cm

FRE3011

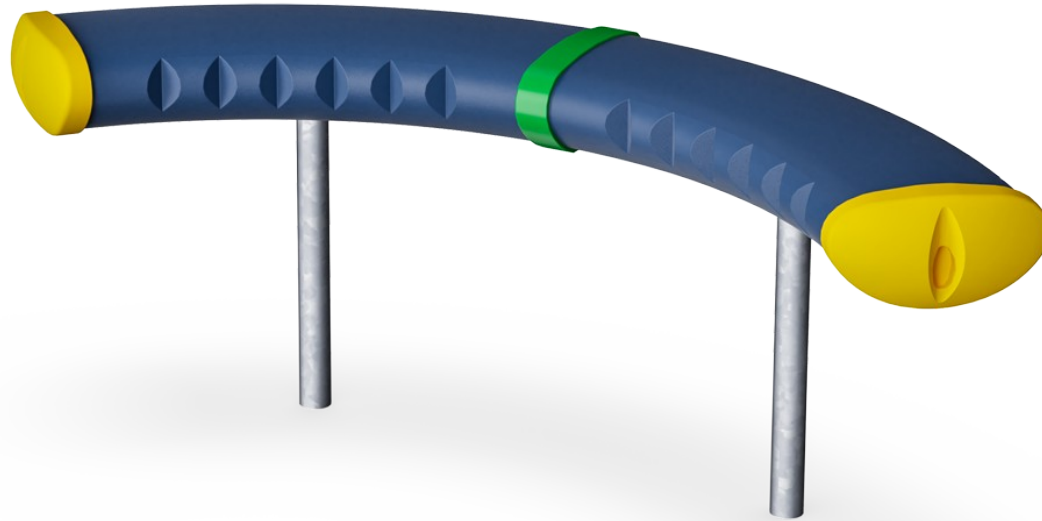

Item no. FRE3011-3417

General Product Information

Dimensions LxWxH	127x108x61 cm
Age group	3+
Play capacity (users)	-
Color options	

The curved benches can be installed in different heights and next to each other to create a tribune. The benches are splendid meeting points to socialise with friends and look at sport activities at the same time.



Bench C 60cm

FRE3011

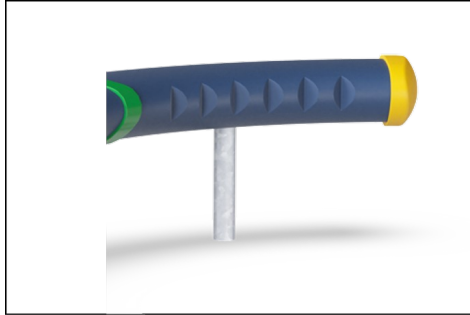

The steel surfaces are hot dip galvanised inside and outside with lead free zinc. The galvanisation has excellent corrosion resistance in outside environments and requires low maintenance.



KOMPAN GreenLine versions are designed with ultimate environmentally friendly materials with lowest possible CO₂e emission factor such as EcoCore™ panels of 100% post consumer recycled ocean waste.

Item no. FRE3011-3417

Installation Information

Max. fall height	0 cm
Safety surfacing area	0.0 m ²
Total installation time	1.9
Excavation volume	0.29 m ³
Concrete volume	0.10 m ³
Footing depth (standard)	60 cm
Shipment weight	32 kg
Anchoring options	In-ground ✓ Surface ✓

Warranty Information



Bench C 60cm

FRE3011

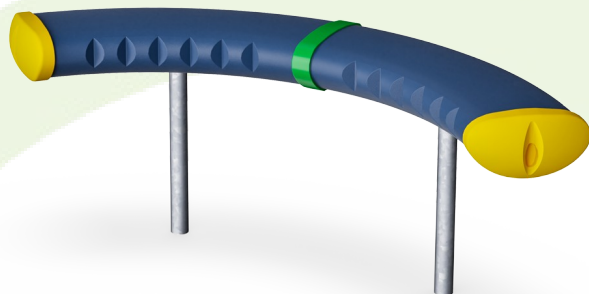

Cradle to Gate A1-A3	Total CO ₂ emission	CO ₂ e/kg	Recycled materials
	kg CO ₂ e	kg CO ₂ e/kg	%
FRE3011-3417	73.80	2.30	25.50
FRE3011-3417DT	71.20	2.22	31.90

The overall framework applied for these factors is the Environmental Product Declaration (EPD), which quantifies "environmental information on the life cycle of a product and enable comparisons between products fulfilling the same function" (ISO, 2006). This follows the structure and applies a Life-Cycle Assessment approach to the entire Product stage from raw material through manufacturing (A1-A3))

Kompan A/S
C.F. Tietgens Boulevard 32C
DK-5220 Odense SØ
Denmark

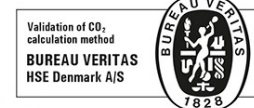

Validation of CO₂ calculation of: Park

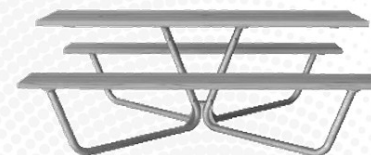

Data version no. 2021-09-27

The CO₂ calculation and data are in compliance with the principles of a carbon footprint impact according to the GHG protocol (Greenhouse Gas Protocol), Scope 3, cradle to gate related to all individual components in the product category: "Park" represented by item no.: PAR4070-0001. (Scope 3 emissions include emission sources in the upstream and downstream value chain).

Date: 15. October 2021 | Valid until: 15. October 2023

Validated by:

Bente Hviid, Senior Consultant

Peter Bendtsen, Senior Consultant

Validation based on report: Validation of CO₂ calculation of 8 categories of Kompan product line, version 1.0, prepared by: Bureau Veritas HSE, Denmark: Bente Hviid and Peter Bendtsen.

Publication date: 15. October 2021

By Bureau Veritas HSE
www.bureauveritas.dk
+45 7731 1000



Bench C 60cm

FRE3011

* Max fall height | ** Total height | *** Safety surfacing area

* Max fall height | ** Total height

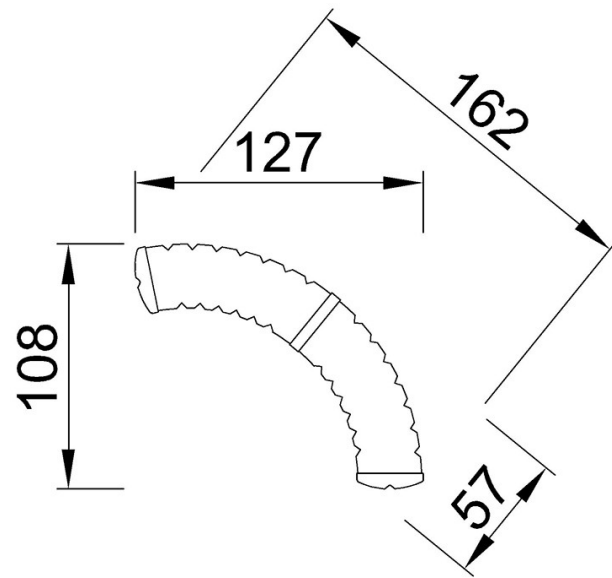

FRE3011
**61cm

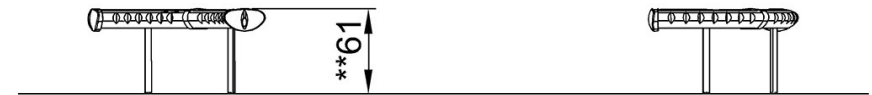

FRE3011

[Click to see TOP VIEW](#)

[Click to see SIDE VIEW](#)